

#### ATEX (FLAMEPROOF)

#### MONOSTABLE

PneuLINK™ linear system is manufactured from 316 stainless steel and brass materials. The ergonomic design ensures an easy set up, trouble free installation and maintenance free operation. The PneuLINK™ dynamic mechanism is both self-compensating and self-aligning, with minimal backlash and hysteresis, for high repeatability and total reliability.

The Valve Control Monitor (VCM) acts as an integral junction box, which facilitates a single multi-core cable for the discrete inputs (DI), and the low power solenoid discrete output (DO), reducing site cabling and installation costs. PneuLINK™ linear Valve Control Monitor system offers total installation flexibility and can be fitted in various pre-selected positions (refer page 3 & 4).

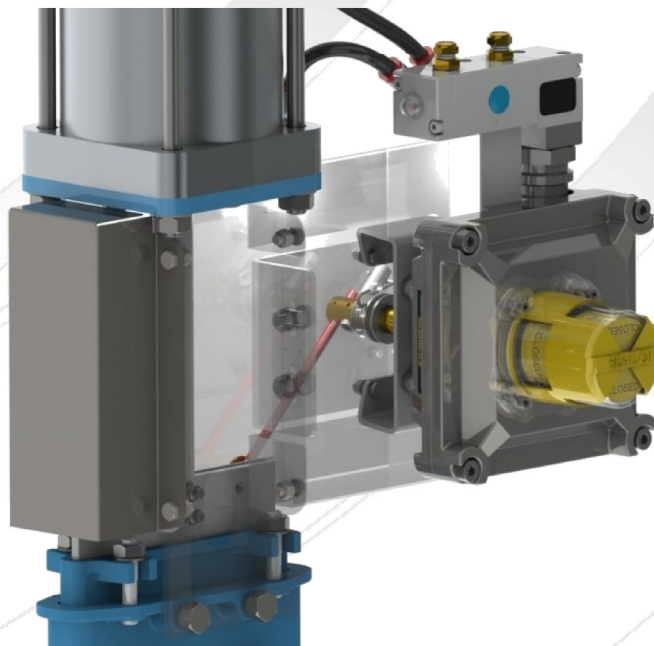

#### Ex II 2GD Ex d IIB + H2 T6..T4 IP6X

#### FEATURES AND BENEFITS

- For use within potentially explosive atmospheres.  
Ex II 2G Ex d IIB + H2 T6 to T4  
Ex tb IIIC T\* Db IP6X  
-30°C to + 85°C (T4/ T130°C) , -30°C to +60°C (T6/ T80°C)
- IP66/67 316 stainless steel enclosure ensures both strength and corrosion resistance for installation in harsh environments.
- Beacon shaped visual indication provides 360° visual feedback of valve OPEN (Black) or CLOSED (Yellow) positions.
- Black / Yellow colours, as a visual indicator, offers high visibility integrity, and is colour impaired friendly.
- Touch set cams are hand adjustable, spring loaded and self-locking, providing quick calibration of position switches and sensors.
- SPDT mechanical switches or proximity switches.
- Switch centralization plate allows for the accurate setting of switches, improved repeatability, and minimises hysteresis.
- NAMUR VDI/VDE standard mounting arrangement.
- Quick release design of terminal strip bracket allows removal of the terminal strip, which is pre-wired and numbered, to aid field wiring at commissioning and installation stage.
- M20 conduit entries fitted with ATEX certified, IP rated plugs as standard to avoid ingress during site storage and transportation prior to installation.
- Extra conduit entry for easy field wiring as standard.
- SOV with red pneumatic indicator as standard.
- Solenoid coil integrated within the VCM housing, and is available with a choice of coil voltages.
- 316 stainless steel solenoid valve, in 3 or 5 way configurations.
- Optional Cv ratings of 1.1 or 3.5
- Exhaust port flow regulators fitted as standard.



For More information scan the QR Code on the left or visit <http://www.pneuton.co.uk/>

Copyright © 2014 PNEUTON. All rights reserved. 801 005 XXX (11/14)

We reserve the right to amend the specification without prior notification

### ATEX (FLAMEPROOF)

### TECHNICAL SPECIFICATION

The Valve Control Monitor contains two switches to indicate the fully open and closed positions of the valve – refer below options

#### STANDARD

#### V3 Mechanical Switches SPDT

Single Pole Double Throw – Form C

##### Resistive Loads

15A @ 250VAC

6A @ 24VDC

0.5A @ 125VDC

0.25A @ 250VDC

##### Inductive Loads

10A @ 250VAC

6A @ 24VDC

0.5A @ 125VDC

0.25A @ 250VDC

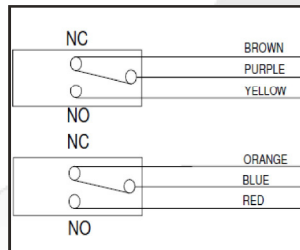

**Note:** Lamp & Motor loads refer **Dr Pneuton** for guidance!

#### OPTION 1

#### Magnum XT-90 Switches SPDT

Magnum XT-90 hermetically sealed proximity switch

Single Pole Double Throw – Form C

Tungsten Contacts

##### Resistive Loads

1.5A @ 250VAC

3.0A @ 120VAC

2.0A @ 24VDC

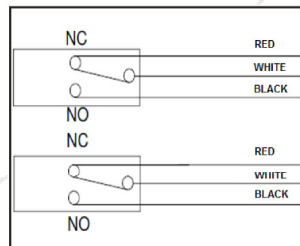

**Note:** Inductive and lamp loads refer **Dr Pneuton** for guidance!

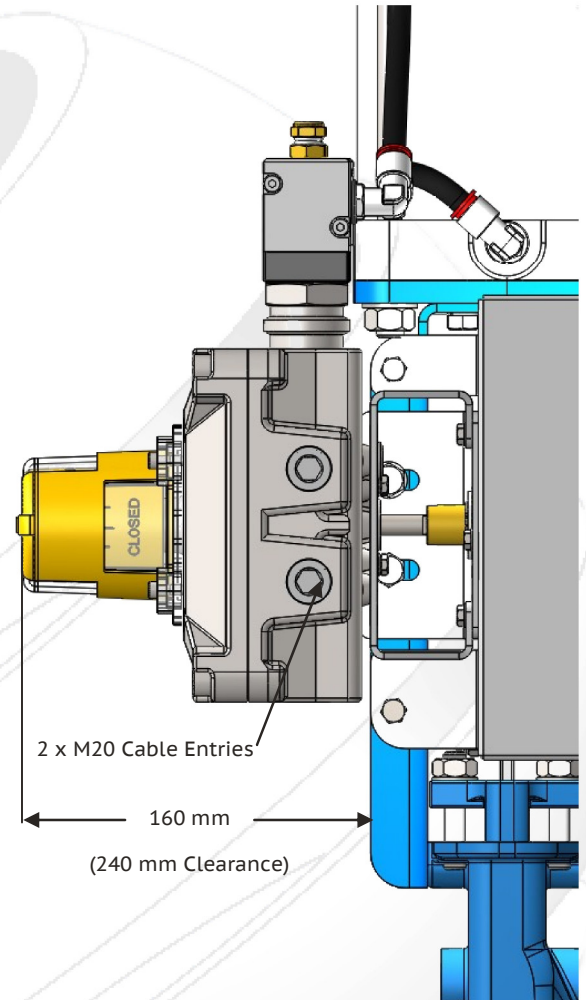

#### OPTIONS

#### Switches & Transmitters

V3 SPDT mechanical switches (4 /5\*/6\*-off)

(\* High cover required)

DPDT switches (2 /3\*/4\*-off)

(\* High cover required)

Inductive proximity sensors (2 or 4-off)

Resistive position transmitters (RS) – 1KΩ (standard), optional 5KΩ or 10KΩ

Current position transmitters (CS), 2 wire loop powered, 4-20mA @ 18 to 24V DC

Fieldbus connectivity - AS-I, DeviceNet, Modbus, Profibus & Foundation Fieldbus

Conduit entry options: M25 x 1.5, 1/2" NPT or 3/4" NPT

Refer **Dr Pneuton** for guidance!

#### SOV

#### Characteristics

**Pneumatic Porting** : G1/4" (standard) or G1/2"

**Operating Pressure** : 3.1 – 8.3 bar (g)

**Air Quality** : ISO 8573-1 Class 5

**Flow Rate** : 1100 NL/min (standard) or 3500 NL/min

**Coil Class Insulation** : H

**Electrical Safety** : IEC335

**Duty Rating** : 100%

Standard Voltages	Inrush ~ (VA)	Nominal ~ (VA)	Watts
24V DC (±10%)			0.7
110VAC / 50Hz (±10%)	-	4.0	0.7
220VAC / 50Hz (±10%)	-	4.0	0.7

**Note :** Other voltages and 60Hz are available on request



For More information scan the QR Code on the left or visit <http://www.pneuton.co.uk/>

Copyright © 2014 PNEUTON. All rights reserved. 801 005 XXX (11/14)

We reserve the right to amend the specification without prior notification

### ATEX (FLAMEPROOF)

### LOGIC SELECTOR

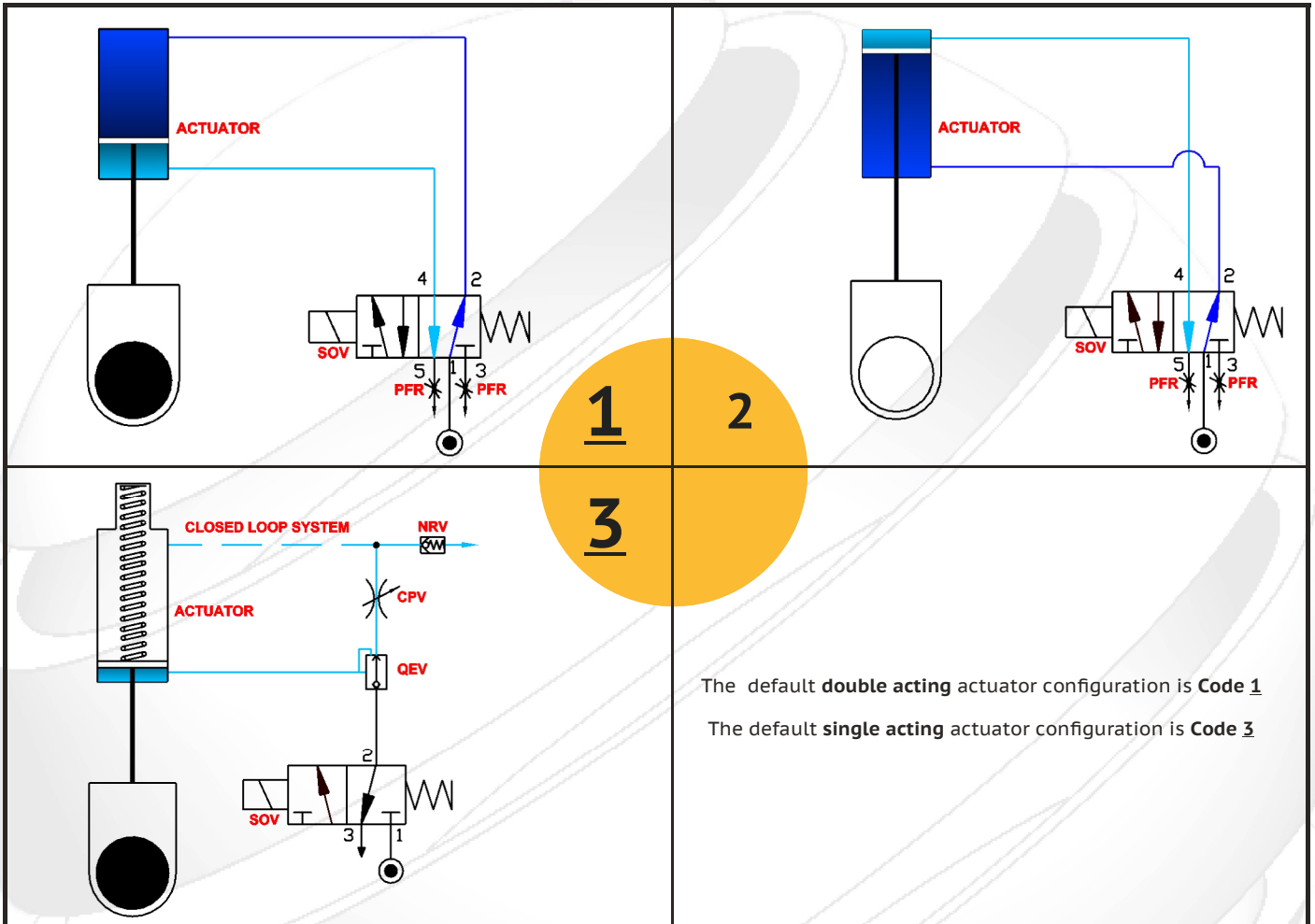

The default **double acting** actuator configuration is **Code 1**  
 The default **single acting** actuator configuration is **Code 3**

**Note:** Typical standard logic applications illustrated, refer **Dr Pneuton** for any alternative requirements!

Option	Loss of air	Loss of power
1	Fail Last *	Fail Close with Motive Power
2	Fail Last *	Fail Open with Motive Power
3	Fail Close or Open Depending on Spring Configuration, with closed loop breather system†	Fail Close or Open Depending on Spring Configuration

\* Valves in the fully open / closed position, with actuator vertically installed, may drift in the absence of motive power!

† Select the closed loop breather system for arduous environments or potentially explosive atmospheres to refresh the non-pressurised side of the actuators piston on the spring strokes negative displacement, to prevent ingress.

Refer **Dr Pneuton** for guidance !



For More information scan the QR Code on the left or visit <http://www.pneuton.co.uk/>

Copyright © 2014 PNEUTON. All rights reserved. 801 005 XXX (11/14)

We reserve the right to amend the specification without prior notification

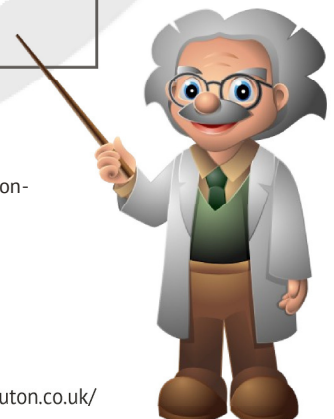

#### ATEX (FLAMEPROOF)

#### CONFIGURATOR

The default VCM configuration is Code A.

It is important that the preferred configuration is defined at point of order.

Refer to optional configurations illustrated below.

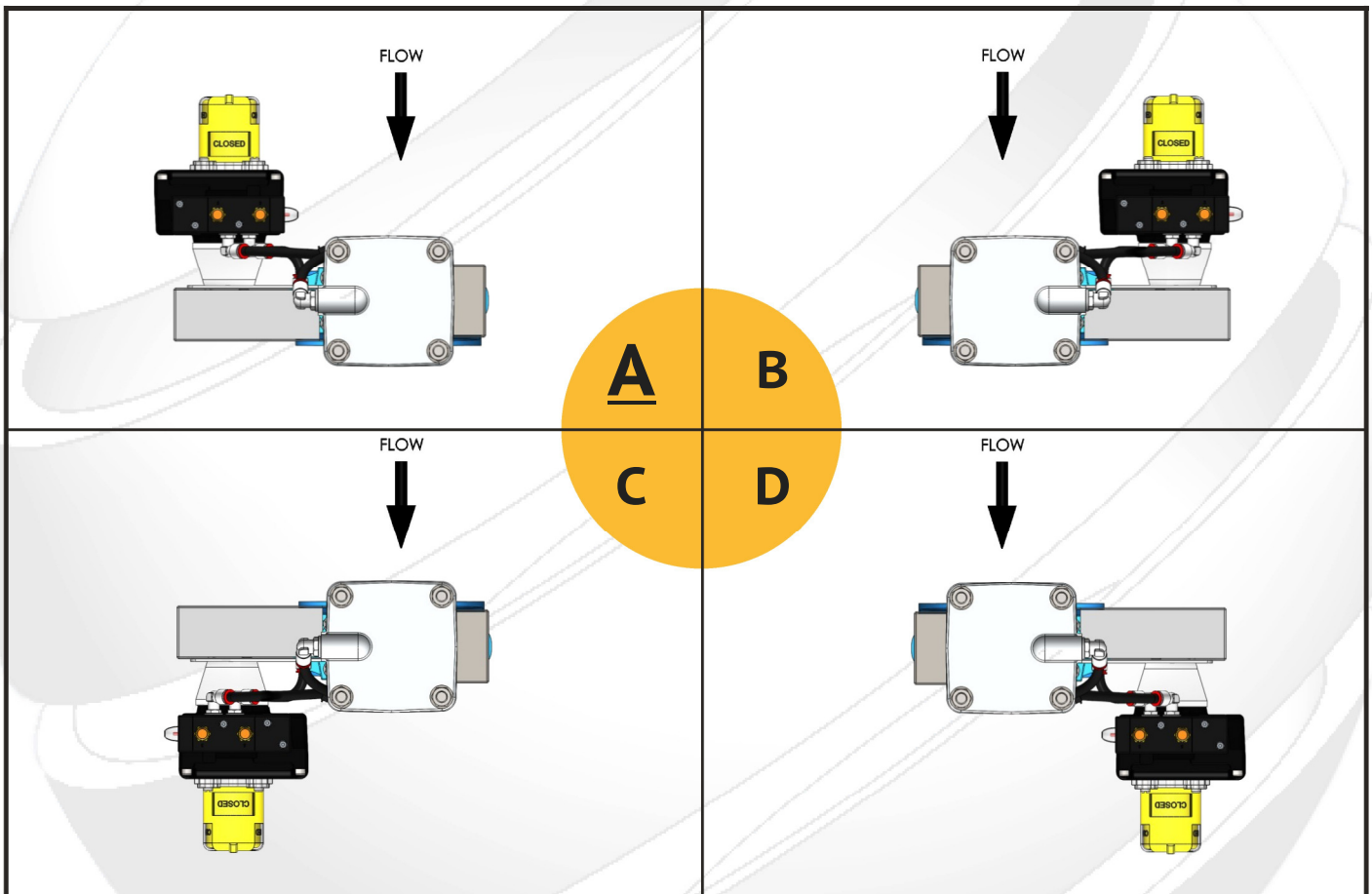

Images shown from actuator end view



For More information scan the QR Code on the left or visit <http://www.pneuton.co.uk/>

Copyright © 2014 PNEUTON. All rights reserved. 801 005 XXX (11/14)

We reserve the right to amend the specification without prior notification

# Pneuton

ENGINEERING VALVE AUTOMATION COMPLIANCE

## PneuLINK™

### VALVE CONTROL MONITOR

**ATEX (FLAMEPROOF)**



Units 6-7 Clock Park,  
Shripney Road,  
Bognor Regis,  
West Sussex,  
United Kingdom,  
PO22 9NH.

Phone UK & Ireland : 01243 810240  
Phone Int.l: +44 (0) 1243 860664

Email: [webenquiries@pneuton.co.uk](mailto:webenquiries@pneuton.co.uk)



For More information scan the QR Code on the left or visit <http://www.pneuton.co.uk/>

Copyright © 2014 PNEUTON. All rights reserved. 801 005 XXX (11/14)

We reserve the right to amend the specification without prior notification